

SECTION B-B  
SCALE 1:5

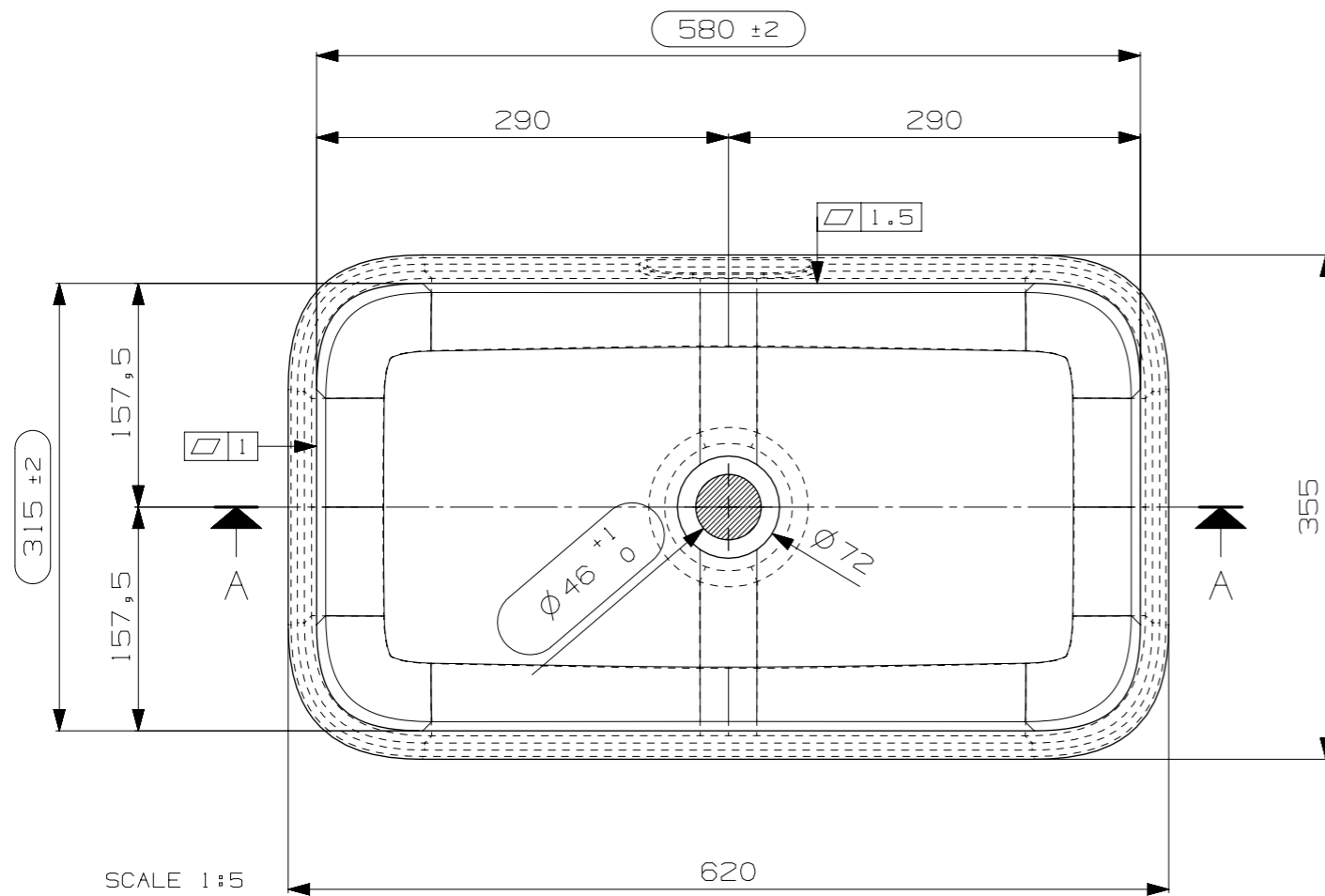

N° STAMPO/Mould Number  
C01149A  
TORO BATH