

SECTION E-E
SCALE 35:200

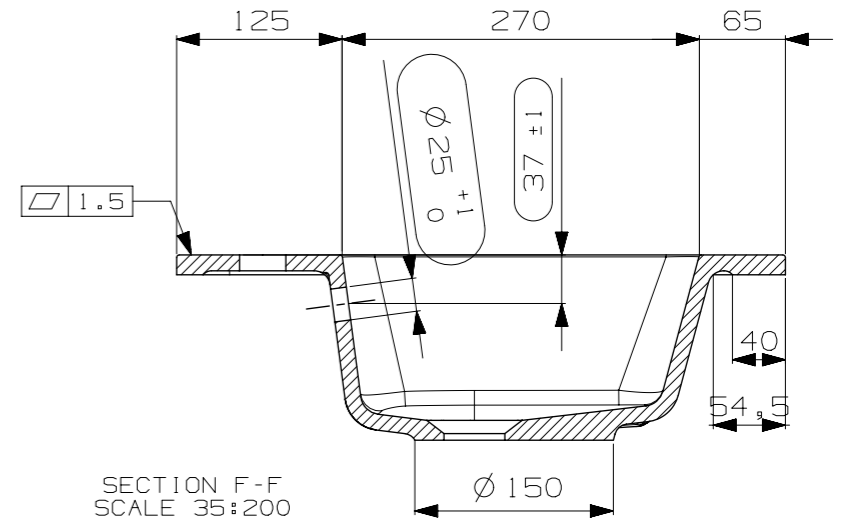

SECTION F-F
SCALE 35:200

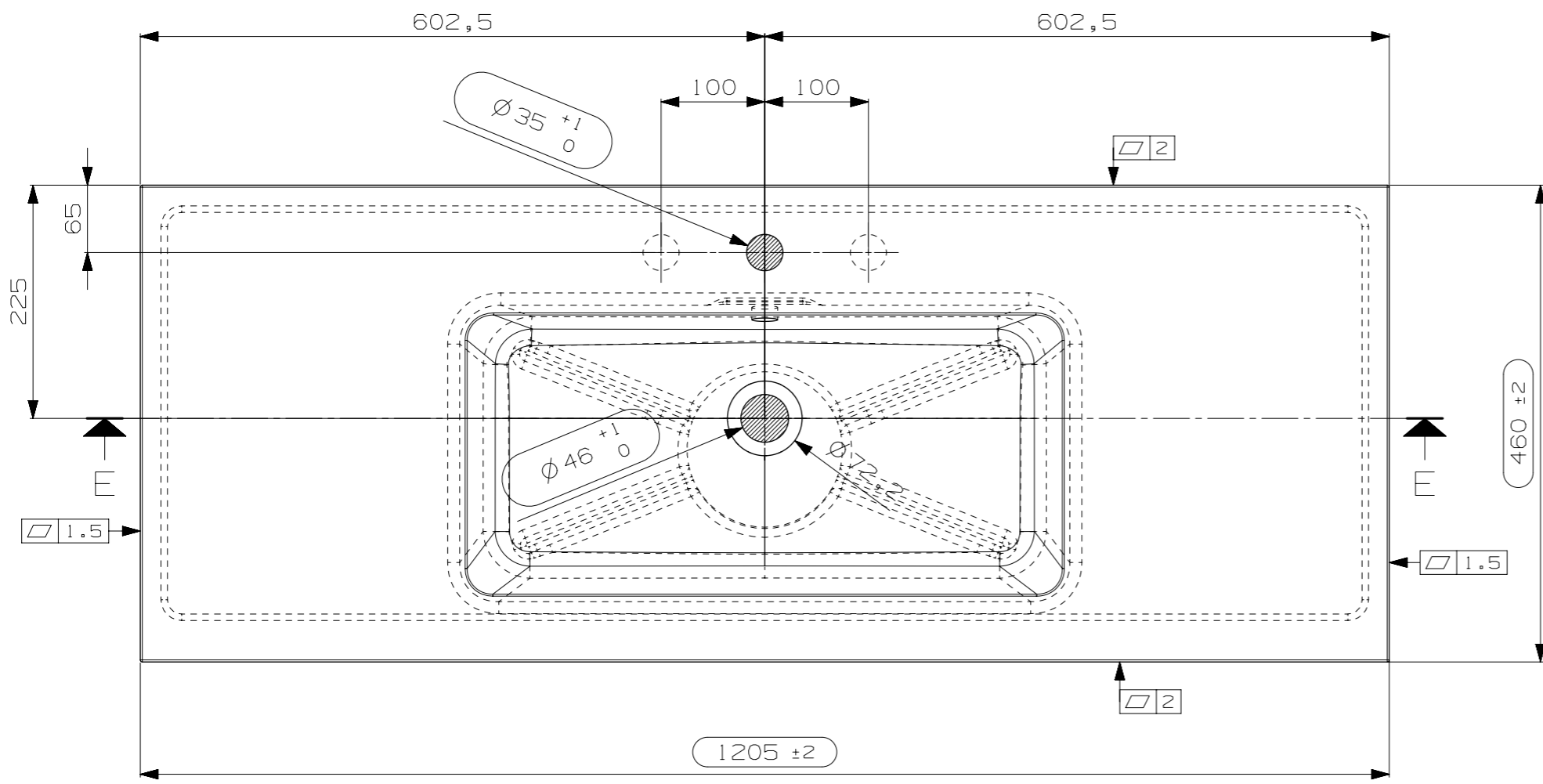

N° STAMPO/Mould Number
M08129B
TORO BATH