

SECTION E-E  
SCALE 35:200

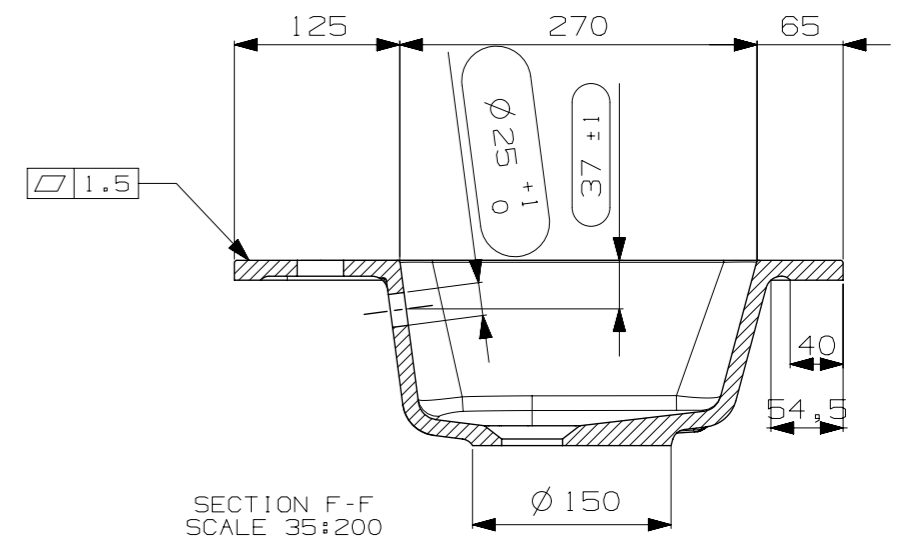

SECTION F-F  
SCALE 35:200

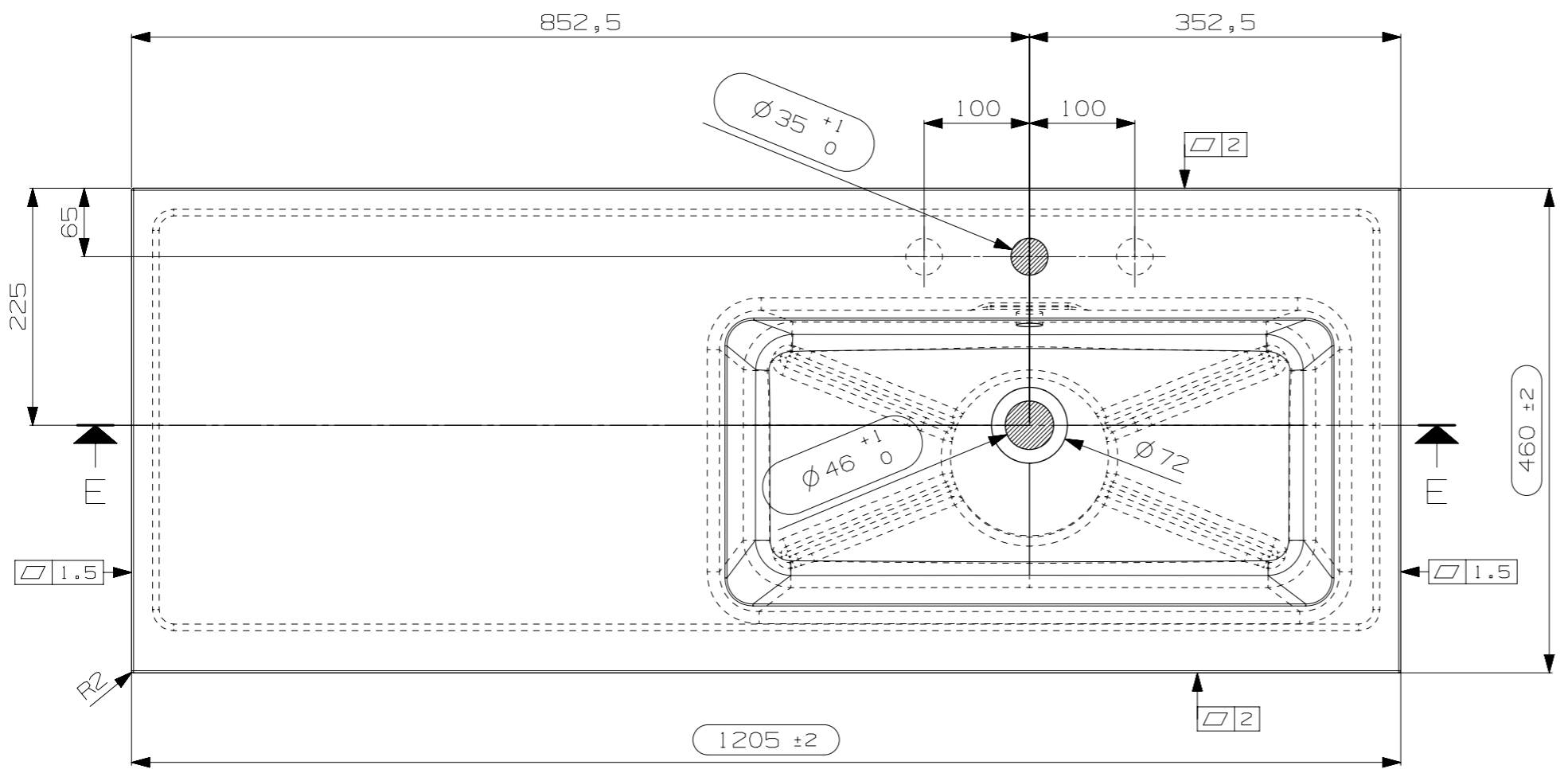

N° STAMPO/Mould Number  
M08132B  
TORO BATH