

SECTION H-H
SCALE 35:200

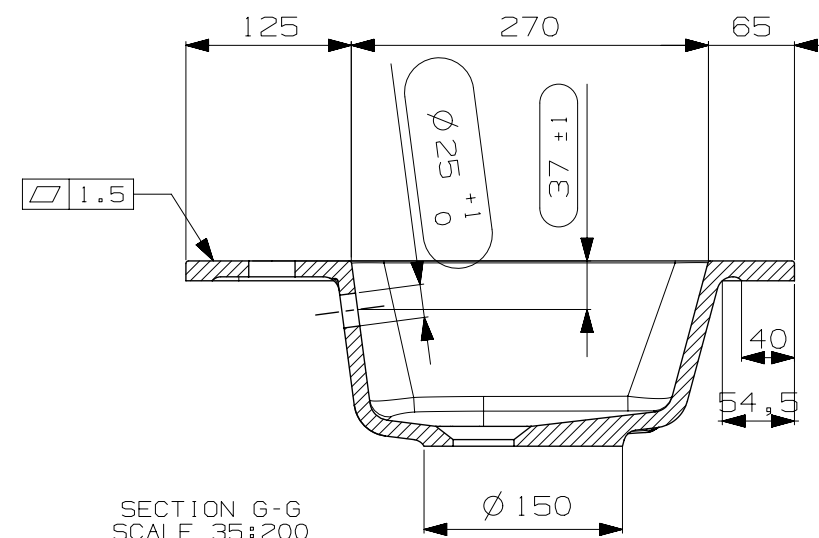

SECTION G-G
SCALE 35:200

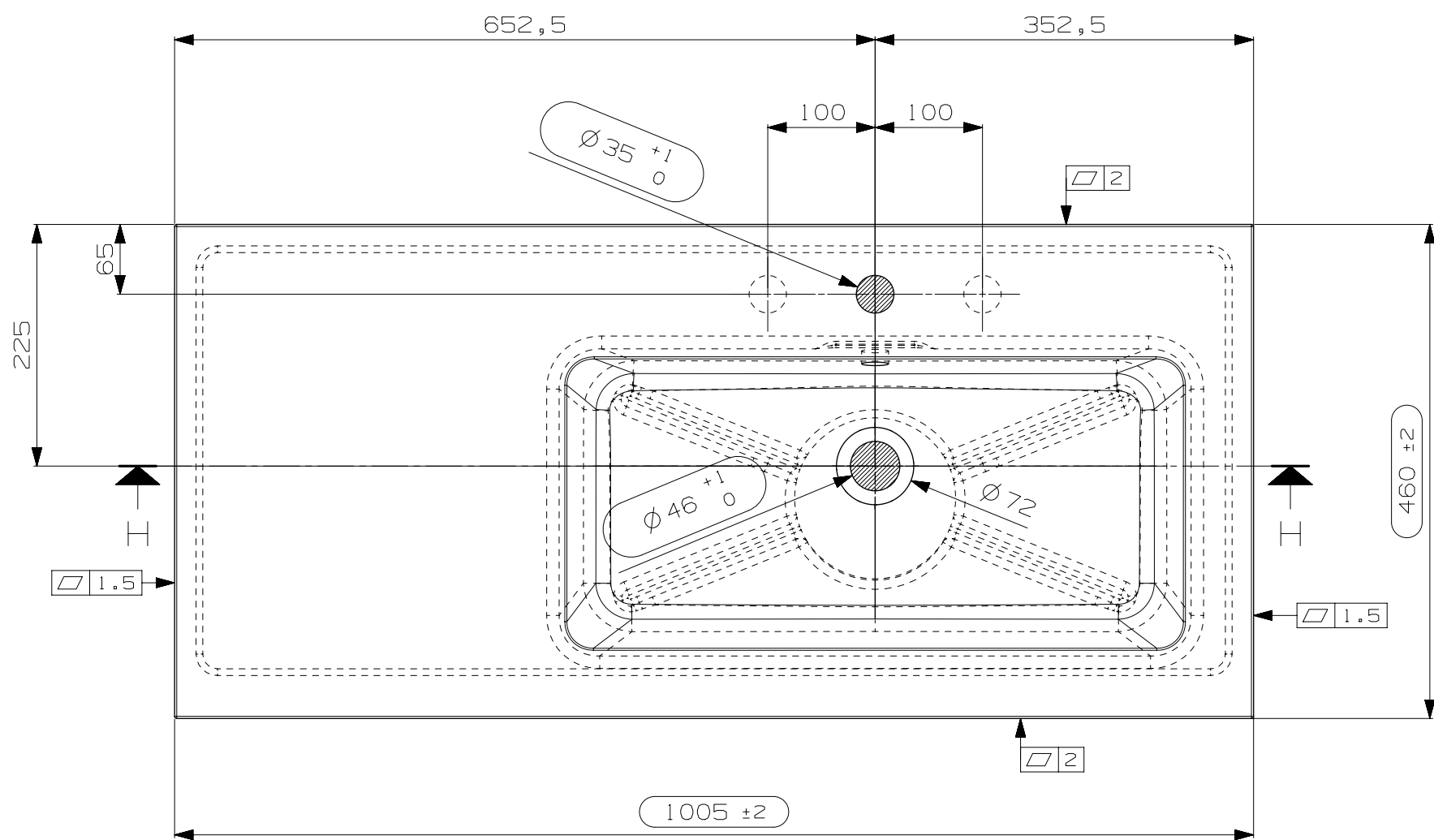

N° STAMPO/Mould Number
M08190B
TORO BATH